



OPERATING & INSTALLATION INSTRUCTIONS

INTRINSICALLY SAFE

3XCS SERIES



PLEASE READ CAREFULLY BEFORE INSTALLING

Installation Bulletin P/N: 239461

Rev C

INTRODUCTION

The 3XCS series product is a pressure transducer which provides linear electrical output proportional to applied pressure and is intended for use for pressure measurement. The 3XCS series is CSA certified Intrinsically Safe for use in: **Class I, Division 1, Groups C and D; Single Seal**

Class I, Zone 0 Exia IIB T4 Ga; Class I, Zone 0 AExia IIB T4 Ga

Intrinsically-safe transducers with 2 or 3 pin outputs or a 3-wire screened cable ‘conduit’ version are available with pressure output only. See Pin out table CONNECTION INFORMATION section for details.

MODEL SPECIFICATION: 3XCSdaaaaabbcfef

Where:

X = 1 or 2

CODE	Type
1	Standard Duty
2	Heavy Duty

d = Output Code

CODE	DESCRIPTION (Output)	OUTPUT TYPE
B	4-20mA	Current
C	1-6V	Absolute
D	1-11V	Absolute
E	0.25-5V	Absolute
F	0.1-5.1V	Absolute
G	0.2-10.2V	Absolute
H	1-5V	Absolute
N	0.5-4.5V Non Ratio-metric	Absolute
P	1-10V	Absolute
R	0-5V	Absolute
S	0-10V	Absolute
T	0.5-4.5V Ratio-metric	Ratio-Metric
V	0.5-4V	Absolute
Z	Place Holder in Compliance with Schedule Drawing 1051-100-OSD	

aaaa = Pressure Range Code

CODE	PRESSURE RANGE (Bar)
0004G	4 bar Gauge
0006G	6 bar Gauge
0007G	7 bar Gauge
0010G	10 bar Gauge
0016G	16 bar Gauge
0025G	25 bar Gauge
0040G	40 bar Gauge
0060G	60 bar Gauge
0100S	100 bar Sealed
0160S	160 bar Sealed
0250S	250 bar Sealed
0400S	400 bar Sealed
0600S	600 bar Sealed
1000S	1000 bar Sealed

CODE	PRESSURE RANGE (psi)
075PG	75 psi Gauge
100PG	100 psi Gauge
150PG	150 psi Gauge
200PG	200 psi Gauge
300PG	300 psi Gauge
500PG	500 psi Gauge
600PG	600 psi Gauge
750PG	750 psi Gauge
10CPG	1000 psi Gauge
50CPG	5000 psi Gauge
75CPG	7500 psi Gauge
060PS	60 psi Sealed
100PS	100 psi Sealed
200PS	200 psi Sealed
300PS	300 psi Sealed
500PS	500 psi Sealed
10CPS	1000 psi Sealed
15CPS	1500 psi Sealed
20CPS	2000 psi Sealed
25CPS	2500 psi Sealed
30CPS	3000 psi Sealed
35CPS	3500 psi Sealed
40CPS	4000 psi Sealed
50CPS	5000 psi Sealed
60CPS	6000 psi Sealed
75CPS	7500 psi Sealed
10KPS	10000 psi Sealed

bb = Pressure Port

CODE	DESCRIPTION (Union Type)
0H	1/2" NPT
02	1/4" - 18 NPT
0E	1/4" - 18 NPT Female
4C	1/4" - 18 NPTF Dryseal
0A	1/4" - 19 PT (JIS) or 1/4" - 19 BSPT
4B	1/4" Female (7/16UN with Schraeder Deflator)
08	1/8" - 27 NPT
4D	1/8" - 27 NPTF Dryseal
4N	3/8" - 24 UNF Union
04	7/16" - 20 (37FLARE.SAE J514 SIZE 4)
1J	7/16" - 20 UNF 2A SA1926/2 O'RING
1P	9/16" - 18UNF 22 A/F
4P	G1/2" A 27A/F
05	G1/4" A Integral Face Seal
01	G1/4" A Stud (BS 5380 Port)
0S	G1/8" A Stud (BS 5380 Port)
2T	M12x1.5 (6g) High Pressure (Washer Seal)
0L	M12x1.5P (6g) O'Ring to ISO 6149-2
0K	M14x1.5P (6g) O'Ring to ISO 6149-2
1G	Schraeder 7-16" - 20 UN 2B Female
ZZ	Place Holder in Compliance with Schedule Drawing 1051-100-OSD

c = Connector Code

CODE	DESCRIPTION (Electrical Connection)
3	1/2" NPT CONDUIT
6	AMP SUPERSEAL 1.5 SERIES
8	DEUTSCH DT04-4P
9	METRIPACK T (150 SERIES)
E	M12
G	EN175301-803 (DIN 43650 A)
R	INDUSTRY STANDARD FORM C
F	INTEGRATED CABLE
Z	Place Holder in Compliance with Schedule Drawing 1051-100-OSD

f = Pressure Restrictor Option

CODE	Type
0	NOT FITTED
R	FITTED

ee = Cable Length

CODE	DESCRIPTION (Cable Length)
00	NOT FITTED
01	1 METRE
02	2 METRE
03	3 METRE
05	5 METRE
10	10 METRE
ZZ	Place Holder in Compliance with Schedule Drawing 1051-100-OSD

HAZARDOUS PRODUCTS

Products which are supplied per this bulletin may be classified as Electrical, Electro-Mechanical and Electronic equipment.

These products are tested and supplied in accordance with our published specifications or individual special requirements that are agreed in writing at time of order. They are constructed so as not to affect adversely the safety of persons and property installed, maintained and used by qualified personnel, in the application for which they were designed and manufactured.

ZENER BARRIER & ENTITY PARAMETERS

Zener Barrier Parameters:

Voltage: $U_i = 30V$ d.c.
Current: $I_i = 100mA$
Power: $P_i = 0.7W$

Entity Parameters:

Signal Current: $I_n = 4-20mA$
Effective Internal Capacitance: $C_i = 323nF$
Effective Internal Inductance: $L_i = 9\mu H$

Values to be added when supplied with Integrated Cable:

Cable Capacitance: $C_i = 300pF / m$ (maximum) Wire to Wire or Wire to Shield
Cable Inductance: $L_i = 2 \mu H / m$ (maximum) Wire to Wire

GENERAL

The equipment is designed and manufactured to:

- a) Avoid physical injury or other harm which may be caused by direct or indirect contact.
- b) Ensure that excess surface temperature of accessible parts or radiation which would cause a danger are not produced.
- c) Eliminate non-electrical dangers which are revealed by experience.
- d) Ensure that foreseeable conditions of overload will not give rise to dangerous situations.

Provided that:

- Pressure range must be compatible with the maximum pressure being measured.
- Pressure media must be compatible with the transducer/transmitter wetted parts listed in these instructions.
- Liquid must not be allowed to freeze in the pressure port.
- The gasket must be fitted under the electrical connector where applicable.

INSTALLATION & START UP

Install and start up the transducer ONLY if it is in a faultless condition. Screw or unscrew the transducer using the hexagon flats ONLY and observing the prescribed torque, do NOT use the electrical connector case for screwing or unscrewing!

Tools required for Installation:

Transducer Mounting: Wrench 22mm or 27mm depending on product

Industry Standard form C Connector and DIN43650 A: Screwdriver

Cables: Where applicable, ensure cable selected is suitable to fit the electrical connector cable gland. On installation of cables and cable glands, ensure all seals are correctly fitted and that cable positioning does not impair ingress protection of seals.

For transducers supplied with integrated cable, minimum bend radius is 75mm.

‘O’ Rings: Transducers are not shipped with soft seals. Process connections which require a soft seal (‘O’ ring) are the responsibility of the installer. They must be suitable for both application temperature and relevant media.

ELECTRICAL INSTALLATION

Installation of this type must be carried out in accordance with the Approved Installation condition for Intrinsically Safe Pressure Transmitters.

Voltage Applications:

The following schematic is applicable for any voltage output – only pull-down configuration shown. External load (RL1) is optional and can be connected between Vout1 and EITHER supply rail.

With “0V offsets”, pull-up resistors cannot be used.

Application Schematic (Example):

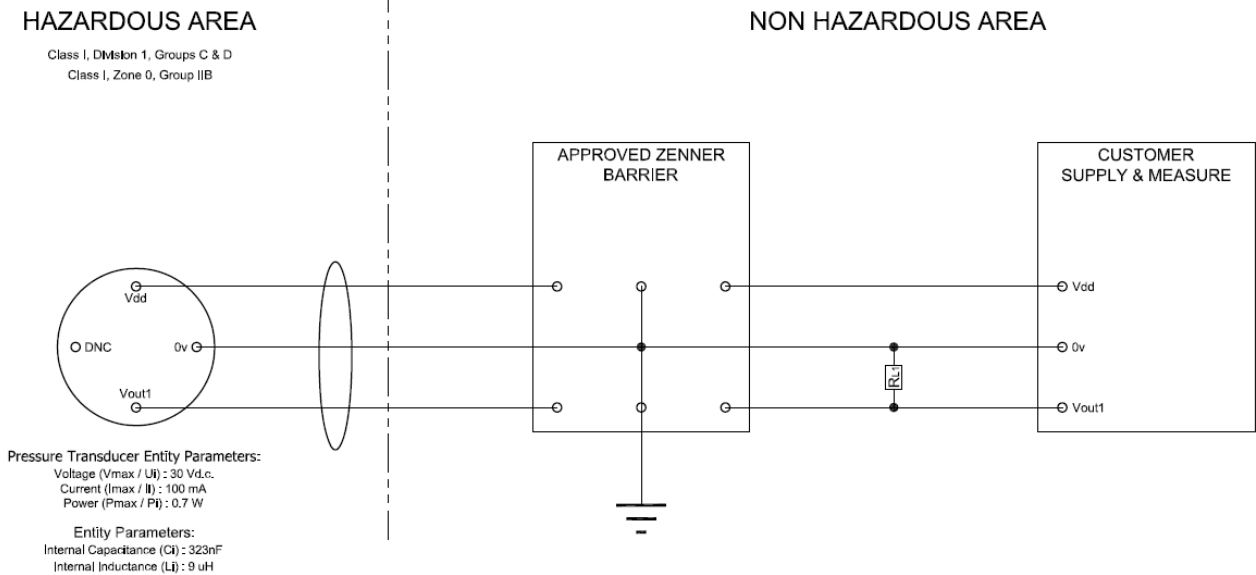

Absolute Output Mode: (Typical output ranges are 0-10V, 0-5V, 1-6V and 1-5V)

Parameter	Min	Typ	Max	Units	Comments
Supply Voltage (Vdd)	8		30	V	Measured at the input to the transducer terminals. For higher operating voltages consult factory
Supply Head-Room to Vout1 Output	1			V	Example: 0-10V doable from 11V supply. This is only valid with no external leads

Supply voltage to product must be limited by appropriate zener barrier as a requirement under I.S.

Ratiometric Output Mode: (Typical output ranges are 0.5-4.5V(r) and 0.25-4.75V(r))
 Various Optional failure diagnostics exist – consult factory:

Parameter	Min	Typ	Max	Units	Comments
Supply Voltage (Vdd)	4.5	5	5.5	V	

General Voltage Output Modes: (Additional Voltage Mode Specification)

Parameter	Min	Typ	Max	Units	Comments
Operating Current Draw		3.5	5.5	mA	With no external loads
Output Impedance	-10%	80	+10%	Ω	
External Load (sink/source current)			2	mA	Any external output load must not sink or source more than 2mA. Consult factory for further limitations

CURRENT APPLICATIONS

The external loop load (R_L) is optional within limits specified below and includes all connection/harness resistances. Load can be placed in either supply line.

Application Schematic (Example):

HAZARDOUS AREA

Class I, Division 1, Groups C & D
 Class I, Zone 0, Group IIB

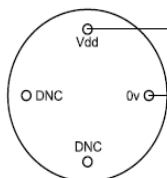

Pressure Transducer Entity Parameters:
 Voltage (V_{max} / U_I): 30 Vd.c.
 Current (I_{max} / I_I): 100 mA
 Power (P_{max} / P_I): 0.7 W

Entity Parameters:
 Internal Capacitance (C_i): 323nF
 Internal Inductance (L_i): 9 uH
 Signal Current (I_n): 4 - 20 mA

NON HAZARDOUS AREA

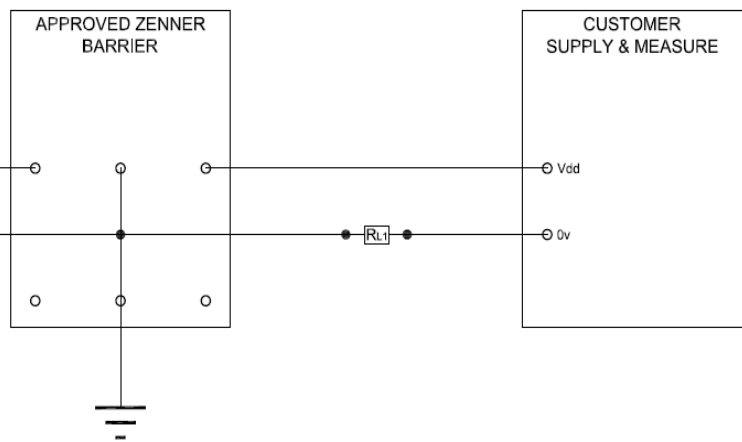

Current Output Mode: (Typical output is 4-20mA)

Parameter	Min	Typ	Max	Units	Comments
Supply Voltage (Vdd)	8		30	V	Measured at the input to the transducer terminals. Customer supply can be greater depending on load used – see graph and summary below.
Pressure Output Current	4		20	mA	Current loop will limit between 25-28mA for protection on overpressure, supply dependent.

Supply voltage to product must be limited by appropriate zener barrier as a requirement under I.S.

R_L Load Limitations for Current Output Mode:

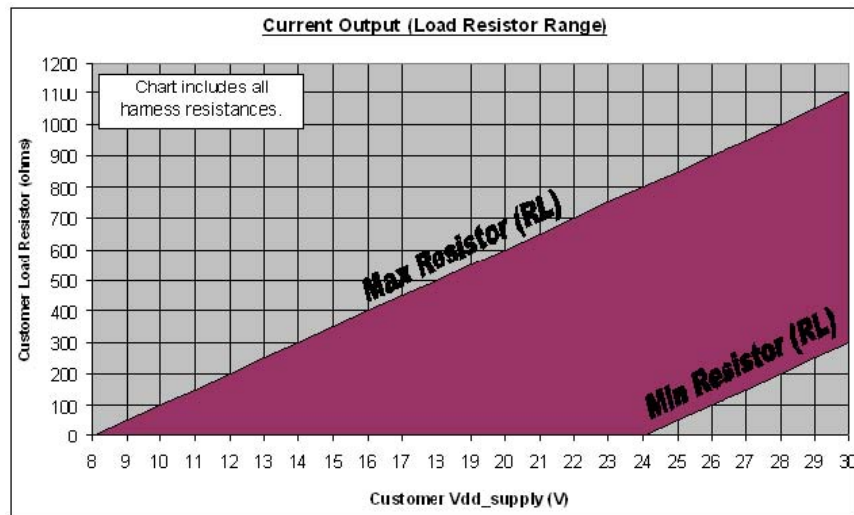

Min Resistor (RL) = 50 * (Vdd - 24) : for Vdd >24V

Max Resistor (RL) = 50 * (Vdd - 8) : for Vdd >8V

SERVICING

The transducer is not to be repaired by the user and must be replaced by an equivalent certified unit. Repairs should only be carried out by the manufacturer or an approved repairer.

RETURN TO FACTORY

PLEASE NOTE: To comply with Health and Safety requirements, the instrument must be clean and safe to handle and accompanied by a formal statement to that effect duly signed by an authorised officer of the Company.

Any instrument returned without certification will be quarantined and no action will occur until cleared. It may ultimately be returned to you and subject to a transportation charge.

MAINTENANCE

Routine Inspection: Not required except for periodic inspection of the cable and connector to ensure that these are neither damaged nor softened by incompatible liquid

STORAGE & DISPOSAL

When storing or disposing of transducer, take precautions with remaining media – it may be hazardous or toxic. Refit thread protection cap during storage periods.

Dispose of transducer and packaging materials in accordance with local waste treatment disposal regulations of the country or region to which the instrument is supplied.

CONNECTION INFORMATION (Please see the available Connector & Pin Assignments below:

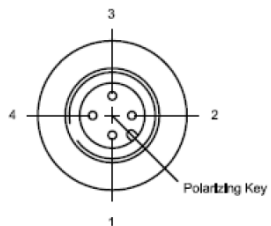
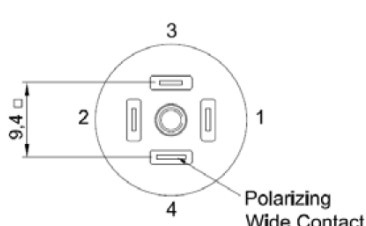
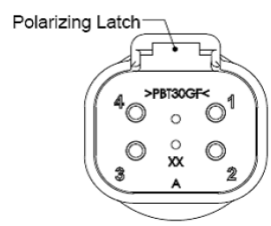
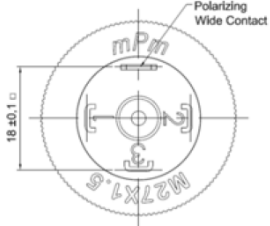
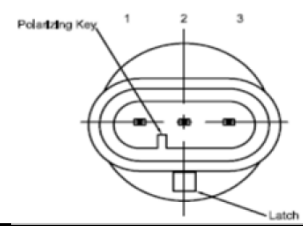
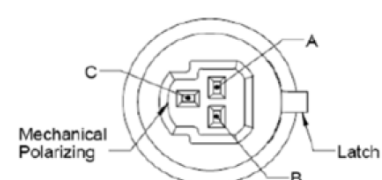
<p>M12:</p>  <table border="1" data-bbox="399 369 750 515"> <thead> <tr> <th>Pin:</th> <th>Voltage:</th> <th>Current:</th> </tr> </thead> <tbody> <tr> <td>1</td> <td>+IN</td> <td>+IN</td> </tr> <tr> <td>2</td> <td>+OP</td> <td>DNC</td> </tr> <tr> <td>3</td> <td>0V</td> <td>0V</td> </tr> <tr> <td>4</td> <td>NC</td> <td>NC</td> </tr> </tbody> </table> <p>Recommended Mating Connector: To IEC 61076-2-101 Hirschmann, Brad Harrison, Lumberg</p>	Pin:	Voltage:	Current:	1	+IN	+IN	2	+OP	DNC	3	0V	0V	4	NC	NC	<p>INDUSTRY STANDARD FORM C:</p>  <table border="1" data-bbox="909 369 1244 515"> <thead> <tr> <th>Pin:</th> <th>Voltage:</th> <th>Current:</th> </tr> </thead> <tbody> <tr> <td>1</td> <td>+IN</td> <td>+IN</td> </tr> <tr> <td>2</td> <td>0V</td> <td>0V</td> </tr> <tr> <td>3</td> <td>+OP</td> <td>DNC</td> </tr> <tr> <td>4</td> <td>NC</td> <td>NC</td> </tr> </tbody> </table> <p>Recommended Mating Connector: Hirschmann GDS 307 Part number 933 024-100 or equivalent</p>	Pin:	Voltage:	Current:	1	+IN	+IN	2	0V	0V	3	+OP	DNC	4	NC	NC
Pin:	Voltage:	Current:																													
1	+IN	+IN																													
2	+OP	DNC																													
3	0V	0V																													
4	NC	NC																													
Pin:	Voltage:	Current:																													
1	+IN	+IN																													
2	0V	0V																													
3	+OP	DNC																													
4	NC	NC																													
<p>DEUTSCH DT04-4P:</p>  <table border="1" data-bbox="383 896 766 1041"> <thead> <tr> <th>Pin:</th> <th>Voltage:</th> <th>Current:</th> </tr> </thead> <tbody> <tr> <td>1</td> <td>0V</td> <td>0V</td> </tr> <tr> <td>2</td> <td>+IN</td> <td>+IN</td> </tr> <tr> <td>3</td> <td>NC</td> <td>NC</td> </tr> <tr> <td>4</td> <td>+OP</td> <td>DNC</td> </tr> </tbody> </table> <p>Recommended Mating Connector: DT064S-P012 as connector plug, W4S-P012 as wedge, 0462-201-1631 as gold socket (x4)</p>	Pin:	Voltage:	Current:	1	0V	0V	2	+IN	+IN	3	NC	NC	4	+OP	DNC	<p>EN175301-803 (DIN 43650 A):</p>  <table border="1" data-bbox="909 907 1244 1052"> <thead> <tr> <th></th> <th>Voltage:</th> <th>Current:</th> </tr> </thead> <tbody> <tr> <td>1</td> <td>+IN</td> <td>+IN</td> </tr> <tr> <td>2</td> <td>0V</td> <td>0V</td> </tr> <tr> <td>3</td> <td>+OP</td> <td>DNC</td> </tr> <tr> <td>4</td> <td>NC</td> <td>NC</td> </tr> </tbody> </table> <p>Recommended Mating Connector: Molex / Brad / mPm Series 121201 (C28300N0S) or equivalent</p>		Voltage:	Current:	1	+IN	+IN	2	0V	0V	3	+OP	DNC	4	NC	NC
Pin:	Voltage:	Current:																													
1	0V	0V																													
2	+IN	+IN																													
3	NC	NC																													
4	+OP	DNC																													
	Voltage:	Current:																													
1	+IN	+IN																													
2	0V	0V																													
3	+OP	DNC																													
4	NC	NC																													
<p>AMP SUPERSEAL 1,5 SERIES:</p>  <table border="1" data-bbox="383 1422 766 1534"> <thead> <tr> <th>Pin:</th> <th>Voltage:</th> <th>Current:</th> </tr> </thead> <tbody> <tr> <td>1</td> <td>+OP</td> <td>DNC</td> </tr> <tr> <td>2</td> <td>0V</td> <td>0V</td> </tr> <tr> <td>3</td> <td>+IN</td> <td>+IN</td> </tr> </tbody> </table> <p>Recommended Mating Connector: 282087-1 as housing, 183025-1 as contact (x3), 281934-3 as wire seal (x3), 880811-2 as protective boot (strain relief)</p>	Pin:	Voltage:	Current:	1	+OP	DNC	2	0V	0V	3	+IN	+IN	<p>METRIPACK T (150 SERIES):</p>  <table border="1" data-bbox="893 1422 1260 1534"> <thead> <tr> <th>Pin:</th> <th>Voltage:</th> <th>Current:</th> </tr> </thead> <tbody> <tr> <td>A</td> <td>0V</td> <td>0V</td> </tr> <tr> <td>B</td> <td>+IN</td> <td>+IN</td> </tr> <tr> <td>C</td> <td>+OP</td> <td>DNC</td> </tr> </tbody> </table> <p>Recommended Mating Connector: 12065286 as connector body 12052893 as connector seal Consult Delphi Packard for appropriate contacts & wire seals.</p>	Pin:	Voltage:	Current:	A	0V	0V	B	+IN	+IN	C	+OP	DNC						
Pin:	Voltage:	Current:																													
1	+OP	DNC																													
2	0V	0V																													
3	+IN	+IN																													
Pin:	Voltage:	Current:																													
A	0V	0V																													
B	+IN	+IN																													
C	+OP	DNC																													
<p>INTEGRATED CABLE / 1/2" NPT CONDUIT:</p> <table border="1" data-bbox="391 1724 758 1848"> <thead> <tr> <th>Colour:</th> <th>Voltage:</th> <th>Current:</th> </tr> </thead> <tbody> <tr> <td>Red</td> <td>+IN</td> <td>+IN</td> </tr> <tr> <td>Black</td> <td>0V</td> <td>0V</td> </tr> <tr> <td>White</td> <td>+OP</td> <td></td> </tr> </tbody> </table>	Colour:	Voltage:	Current:	Red	+IN	+IN	Black	0V	0V	White	+OP		<p>NOTES:</p> <p>DNC : Do Not Connect (Leave Floating). NC : Not Connected at Transducer end.</p> <p>The Integrated Cable is shielded.</p> <p>For compliance with EN 61000-4-5, shielded cable should be used on all transducers.</p>																		
Colour:	Voltage:	Current:																													
Red	+IN	+IN																													
Black	0V	0V																													
White	+OP																														

WARNING: SUBSTITUTION OF COMPONENTS MAY IMPAIR SUITABILITY FOR INTRINSIC SAFETY

AVERTISSEMENT: LE REMPLACEMENT DE COMPOSANTS PEUT NUIRE À LA CONFORMITÉ DE LA SÉCURITÉ INTRINSÈQUE